



LIVOLO

LIVOLO

LIVE ON LOVE

2020 / 2021



119010

A blurred interior scene, possibly a dining area, with a table and chairs. The word "BELA" is overlaid in large, white, bold, sans-serif capital letters in the center of the image. The background is out of focus, showing a table with a red and green object on it, and a dark rectangular object on the wall. The lighting is soft and even.

BELA





A dark, moody interior scene. On the right, a vertical wooden panel with a natural grain texture is illuminated by a warm, yellow light. To the left, a recessed area features a glowing light strip along the top edge, casting a soft glow. In the lower-left foreground, a small, dark green plant with long, thin leaves is visible. The overall atmosphere is sophisticated and minimalist.

CRNA

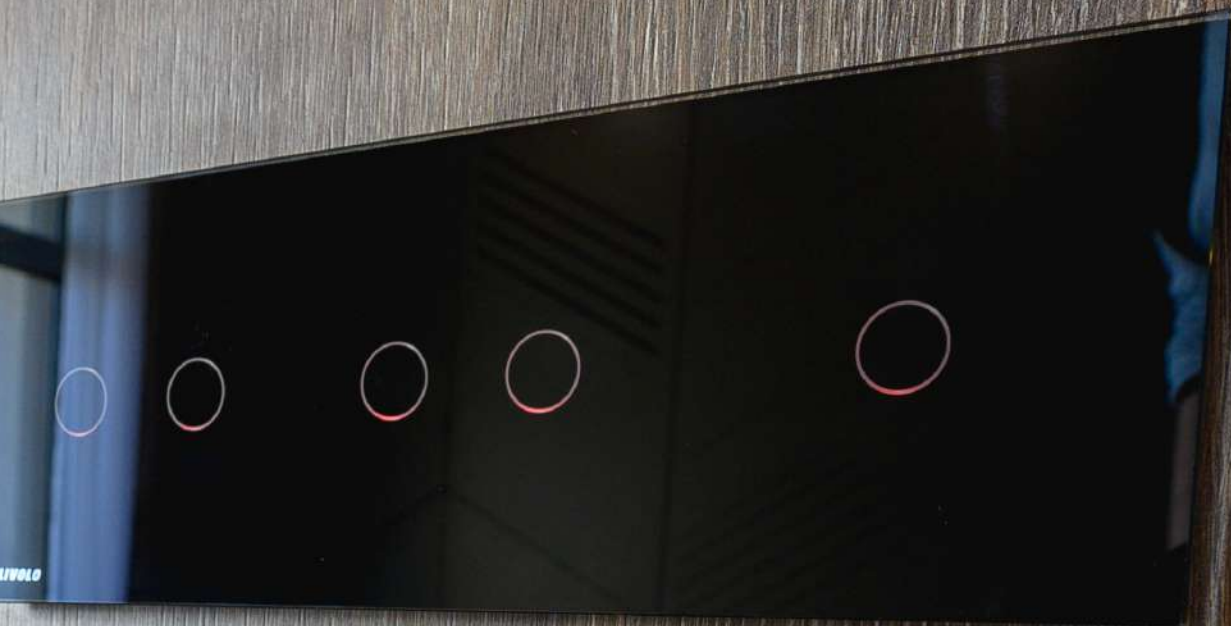

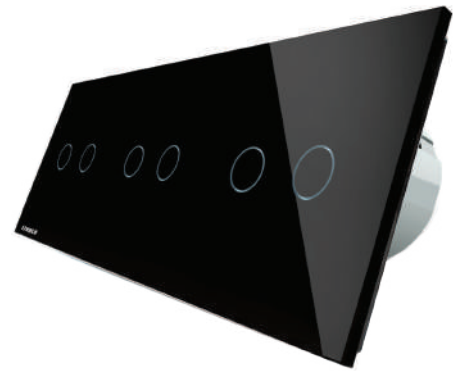



A photograph of a modern interior space. In the foreground, a wall with vertical wooden slats is visible. To the left, a glass-walled hallway leads to another room. The word "ZLATNA" is overlaid in large, bold, white capital letters in the center of the image.

ZLATNA



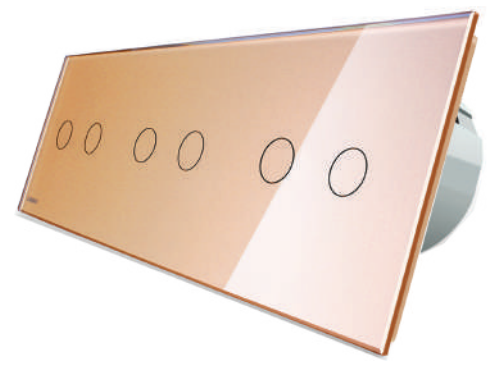
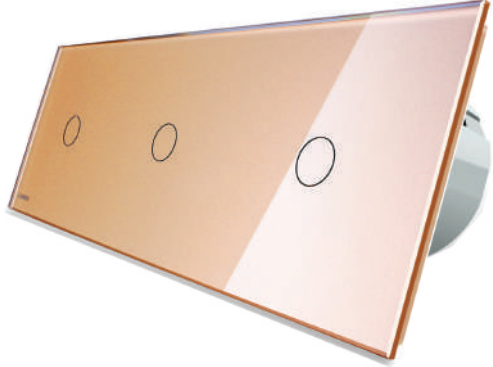



A blurred background image of a staircase with a wooden handrail. A person is visible at the bottom of the stairs, walking. The overall scene is out of focus, with a light blue and grey color palette.

SIVA







SASTAV TOUCH PREKIDAČA



VL-C701

Mehanizam jednopolnog prekidača

-5A

-250V

-max 1000W

BB-C7-C1

Panel za jednopolni prekidač

-kaljeno staklo



NAČIN UGRADNJE

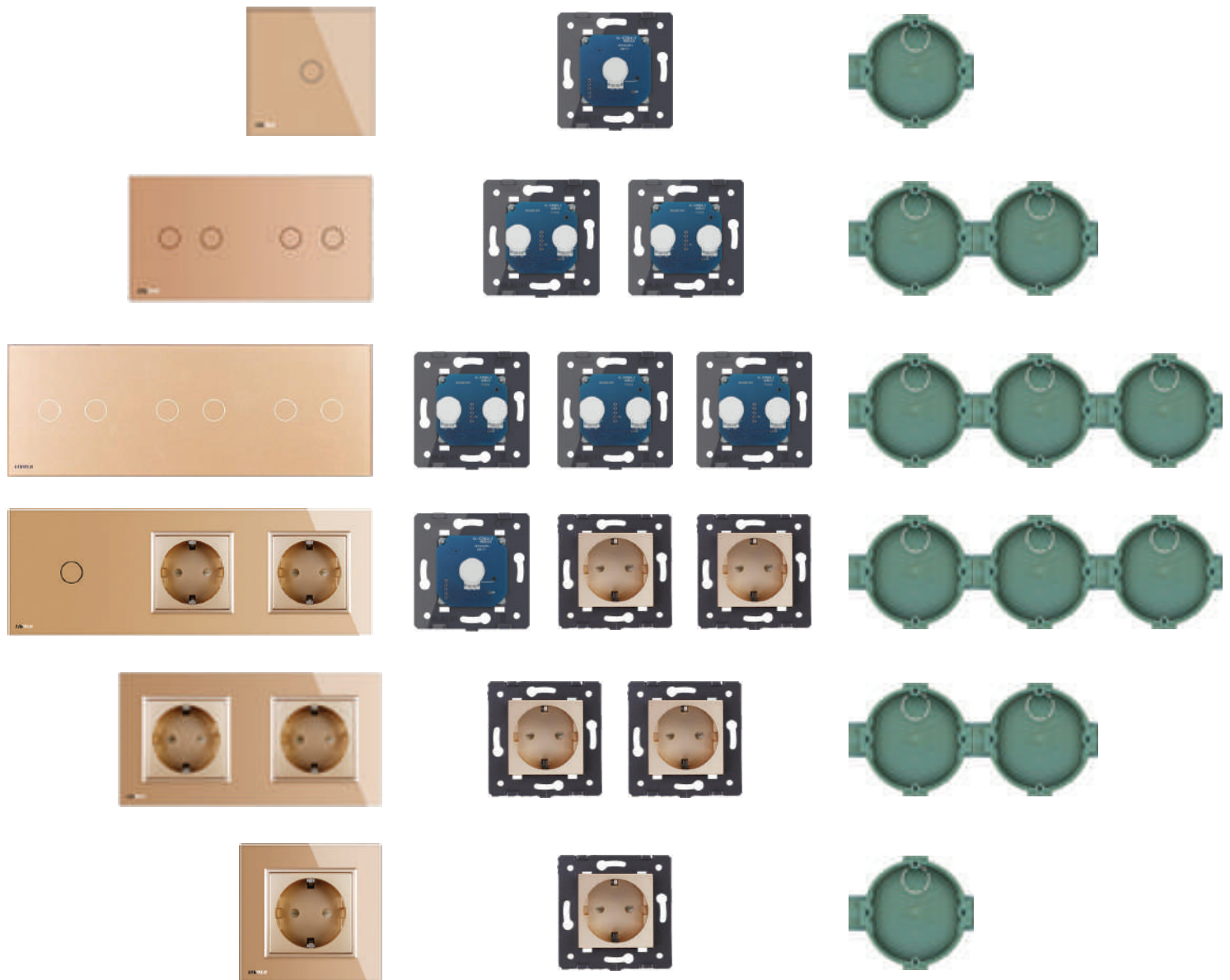











Livolo je premium brend elektrogalanterije. Pored minimalističkog dizajna, odlikuje ga vrhunski kvalitet izrade, u kombinaciji sa najkvalitetnijim materijalima. Paneli su izrađeni od kaljenog stakla, što ih čini izuzetno otpornim na spoljašnje uticaje.













Proizvodi brenda Livolo su mnogo više od običnih prekidača i utičnica, jer enterijeru daju tu završnu notu, i zato su postali neizostavni detalj u projektima mnogih dizajnera entrijera. I baš taj savršeni spoj dizajna i funkcionalnosti je ono što postavlja Livolo proizvode u sam vrh elektrogalanterije.











PANELI PREKIDAČA

	Kataloška oznaka	Naziv	Oznaka boje
	BB-C7-C1	Panel za jednopolni prekidač	 11 12 13 15 Dimenzija (Š/V) mm: 80x80
	BB-C7-C1/C1	Panel za dvostruki jednopolni prekidač	 11 12 13 15 Dimenzija (Š/V) mm: 151x80
	BB-C7-C1/C1/C1	Panel za trostruki jednopolni prekidač	 11 12 13 15 Dimenzija (Š/V) mm: 223x80
	BB-C7-C1/C1/C1/C1	Panel za četverostruki jednopolni prekidač	 11 12 13 15 Dimenzija (Š/V) mm: 294x80
	BB-C7-C1/C1/C1/C1/C1	Panel za petostruki jednopolni prekidač	 11 12 13 15 Dimenzija (Š/V) mm: 365x80











PANELI PREKIDAČA

Kataloška oznaka	Naziv	Oznaka boje
	BB-C7-C2	Panel za serijski prekidač
		 11 12 13 15 Dimenzija (Š/V) mm: 80x80
	BB-C7-C2/C2	Panel za dvostruki serijski prekidač
		 11 12 13 15 Dimenzija (Š/V) mm: 151x80
	BB-C7-C2/C2/C2	Panel za trostruki serijski prekidač
		 11 12 13 15 Dimenzija (Š/V) mm: 223x80
	BB-C7-C2/C2/C2/C2	Panel za četvostruki serijski prekidač
		 11 12 13 15 Dimenzija (Š/V) mm: 294x80
	BB-C7-C2/C2/C2/C2/C2	Panel za petostruki serijski prekidač
		 11 12 13 15 Dimenzija (Š/V) mm: 365x80











PANELI PREKIDAČA

	Katalogška oznaka	Naziv	Oznaka boje
	BB-C7-C2/C1	Panel za serijski i jednopolni prekidač	 11 12 13 15 Dimenzija (Š/V) mm: 151x80
	BB-C7-C1/C2	Panel za jednopolni i serijski prekidač	 11 12 13 15 Dimenzija (Š/V) mm: 151x80
	BB-C7-C2/C2/C1	Panel za dvostruki serijski i jednopolni prekidač	 11 12 13 15 Dimenzija (Š/V) mm: 223x80
	BB-C7-C1/C2/C2	Panel za jednopolni i dvostruki serijski prekidač	 11 12 13 15 Dimenzija (Š/V) mm: 223x80
	BB-C7-C2/C1/C1	Panel za serijski i dvostruki jednopolni prekidač	 11 12 13 15 Dimenzija (Š/V) mm: 223x80223x80

MODULARNI PANELI

	Katalogška oznaka	Naziv	Oznaka boje
	BB-C7-SR	Jednostruki modularni panel	 11 12 13 15 Dimenzija (Š/V) mm: 80x80
	BB-C7-SR/SR	Dvostruki modularni panel	 11 12 13 15 Dimenzija (Š/V) mm: 151x80
	BB-C7-SR/SR/SR	Trostruki modularni panel	 11 12 13 15 Dimenzija (Š/V) mm: 223x80
	BB-C7-SR/SR/SR/SR	Četvorostruki modularni panel	 11 12 13 15 Dimenzija (Š/V) mm: 294x80
	BB-C7-C1/SR	Panel za jednopolni prekidač i jednostruki modul	 11 12 13 15 Dimenzija (Š/V) mm: 151x80











MODULARNI PANELI

Kataloška oznaka	Naziv	Oznaka boje
	BB-C7-SR/C1	Panel za jednostruki modul i jednopolni prekidač
		 11 12 13 15 Dimenzija (Š/V) mm: 151x80
	BB-C7-C1/SR/SR	Panel za jednopolni prekidač i dvostruki modul
		 11 12 13 15 Dimenzija (Š/V) mm: 223x80
	BB-C7-SR/SR/C1	Panel za dvostruki modul i jednopolni prekidač
		 11 12 13 15 Dimenzija (Š/V) mm: 223x80
	BB-C7-C1/SR/SR/SR	Panel za jednopolni prekidač i trostruki modul
		 11 12 13 15 Dimenzija (Š/V) mm: 294x80
	BB-C7-SR/SR/SR/C1	Panel za trostruki modul i jednopolni prekidač
		 11 12 13 15 Dimenzija (Š/V) mm: 294x80

MODULARNI PANELI

	Katalogška oznaka	Naziv	Oznaka boje
	BB-C7-C2/SR	Panel za serijski prekidač i jednostruki modul	 11 12 13 15 Dimenzija (Š/V) mm: 151x80
	BB-C7-SR/C2	Panel za jednostruki modul i serijski prekidač	 11 12 13 15 Dimenzija (Š/V) mm: 151x80
	BB-C7-C2/SR/SR	Panel za serijski prekidač i dvostruki modul	 11 12 13 15 Dimenzija (Š/V) mm: 223x80
	BB-C7-SR/SR/C2	Panel za dvostruki modul i serijski prekidač	 11 12 13 15 Dimenzija (Š/V) mm: 223x80
	BB-C7-C2/SR/SR/SR	Panel za serijski prekidač i trostruki modul	 11 12 13 15 Dimenzija (Š/V) mm: 294x80

MODULARNI PANELI

	Kataloška oznaka	Naziv	Oznaka boje
	BB-C7-SR/SR/SR/C2	Panel za trostruki modul i serijski prekidač	 11 12 13 15 Dimenzija (Š/V) mm: 294x80
	BB-C7-C1/C1/SR	Panel za dvostruki jednopolni prekidač i modul	 11 12 13 15 Dimenzija (Š/V) mm: 223x80
	BB-C7-SR/C1/C1	Panel za modul i dvostruki jednopolni prekidač	 11 12 13 15 Dimenzija (Š/V) mm: 223x80
	BB-C7-C1/C1/SR/SR	Panel za dvostruki jednopolni prekidač i dvostruki modul	 11 12 13 15 Dimenzija (Š/V) mm: 294x80
	BB-C7-SR/SR/C1/C1	Panel za dvostruki modul i dvostruki jednopolni prekidač	 11 12 13 15 Dimenzija (Š/V) mm: 294x80

MEHANIZMI PREKIDAČA

Kataloška oznaka

Naziv



VL-C701

Mehanizam jednopolnog prekidača



VL-C702

Mehanizam serijskog prekidača



VL-C701S





Mehanizam naizmjeničnog jednopolnog prekidača











VL-C702S

Mehanizam naizmjeničnog serijskog prekidača











MEHANIZMI PREKIDAČA

Kataloška oznaka	Naziv
	VL-C701D Mehanizam jednopolnog prekidača sa regulacijom svetlosti
	VL-C701T Mehanizam vremenskog prekidača
	VL-C702W Mehanizam dvosmernog prekidača
	VL-C701B Mehanizam tastera za zvonce



















MODULARNI PROGRAM - UTIČNICE

	Katalogška oznaka	Naziv	Oznaka boje
	VL-C7-C1EU	Jezgro šuko utičnice	 11 12 13 15 A 16 V 250
	VL-C7-C1A	Jezgro euro utičnice	 11 12 A 16 V 250
	VL-C7-1WF	Vodootporni poklopac utičnice	 11 12 13 15
	VL-C7-1C	COM-Mrežni modul UTP	 11 12 13 15 2,1

MODULARNI PROGRAM - UTIČNICE

	Kataložka oznaka	Naziv	Oznaka boje
	VL-C7-1V	TV-modul	 11 12 13 15
	VL-C7-1T	TEL-modul	 11 12 13 15
	VL-C7-1AD	AUDIO-modul	 11 12 13 15
	VL-C7-1HD	HDMI-modul	 11 12 13 15 2,1
	VL-C7-1USB	USB-modul	 11 12 13 15

SENZORI, TERMOSTATI, OSTALO...

	Katalogška oznaka	Naziv	Oznaka boje
	VL-C701RG	PIR-Senzor (senzor pokreta)	 11  12  13  15 V 250
	VL-C7-01TM	Termostat	 11  12  13  15 V 250
	102700102	ZigBEE Hub (WiFi Ruter)	
	VL-PJ01	Adapter za dimovanje LED sijalica manje snage	 11  12  13  15 V 250
	VL-PJ07	Dekorativni srebrni ram	







ZIG BEE



Livolo je pored klasičnih touch prekidača, u svoju ponudu uveo **Zig Bee** smart prekidače i utičnice.

Zatim se putem smart hub-a povezuju wi fi mrežom jedni za druge i onda ih kontrolišete aplikacijom na smart telefonu ili tabletu. Moguće ih je grupisati i praviti razne scenarije i automatizaciju. Instalacija Zig Bee sistema se ne razlikuje od povezivanja klasičnih touch prekidača i nije im potrebna nula, što je jedinstveno na tržištu i mnogostruko olakšava montažu i korišćenje.

ZIG BEE MODULARNI PROGRAM

	Kataloška oznaka	Naziv
	VL-C7-01Z	ZigBee jednopolni prekidač sa daljinskom kontrolom
	VL-C702Z	ZigBee serijski prekidač sa daljinskom kontrolom
	VL-C701SZ	ZigBee naizmjenični jednopolni prekidač sa daljinskom kontrolom
	VL-C702SZ	ZigBee naizmjenični serijski prekidač sa daljinskom kontrolom
	784000811	ZigBee jezgro šuko utičnice

ŠEME POVEZIVANJA

Jednopolni prekidač

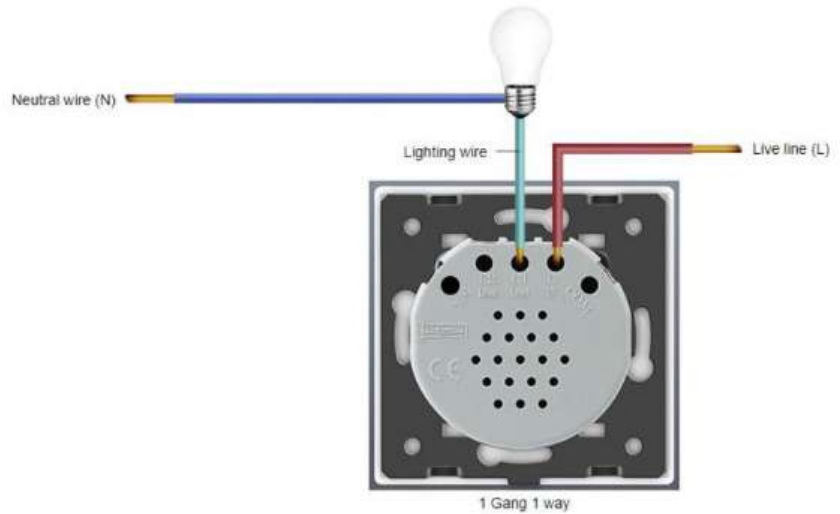

Serijski prekidač

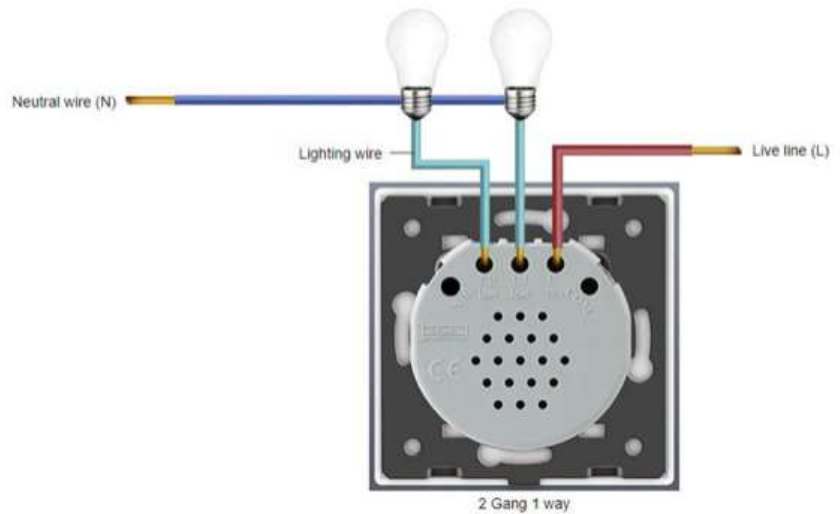

Prekidač za roletne

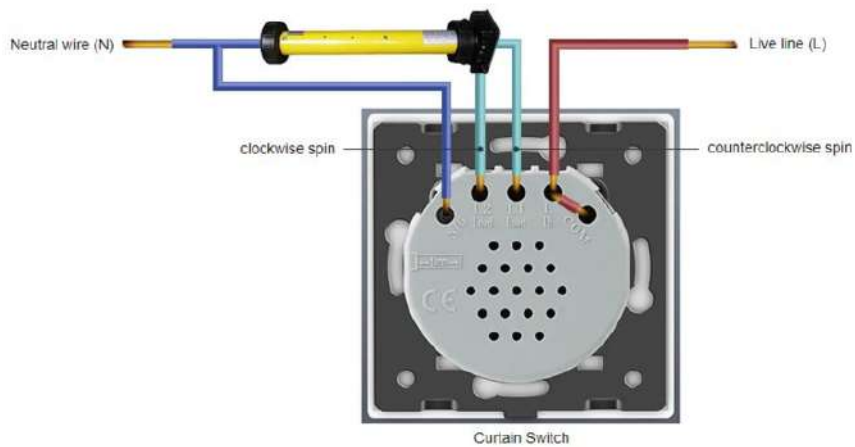

Jednopolni naizmienični prekidač

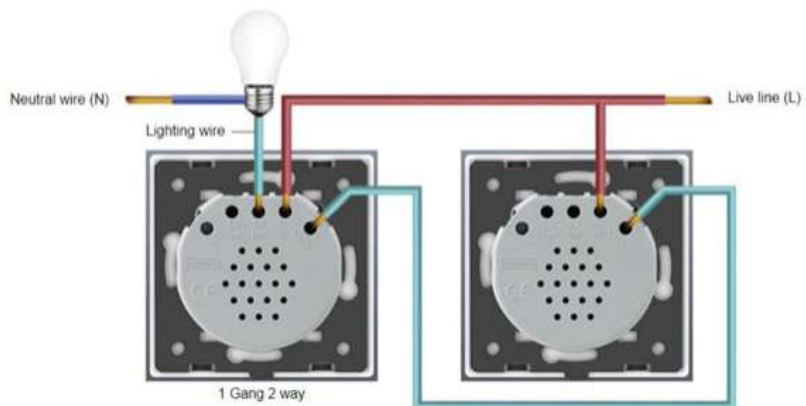

Serijski naizmienični prekidač

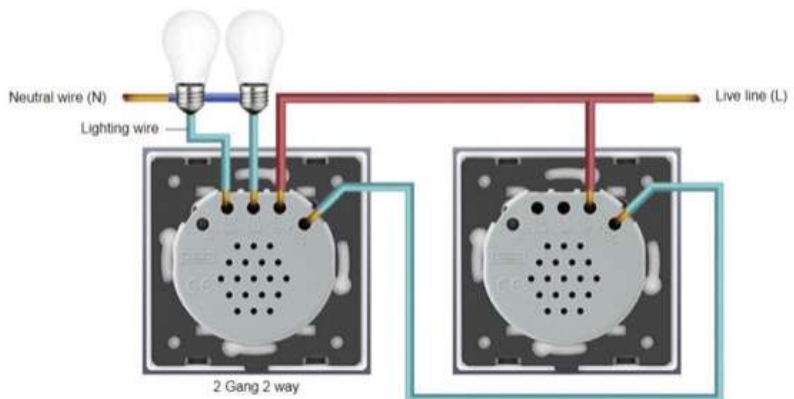

LIVOLO

LIVE ON LOVE

2020 / 2021



LIVOLO